

**RF & MICROWAVE TRANSISTORS
 TV BAND III APPLICATIONS**

- FREQUENCY 170 – 230MHz
- POWER OUT 200 W
- VOLTAGE 32V
- POWER GAIN 11dB
- CLASS AB PUSH PULL
- DESIGNED FOR HIGH POWER LINEAR OPERATION
- HIGH SATURATED POWER CAPABILITY
- GOLD METALLIZATION FOR HIGH RELIABILITY
- DIFFUSED EMITTER BALLASTING RESISTORS
- COMMON EMITTER CONFIGURATION
- INTERNAL INPUT MATCHING

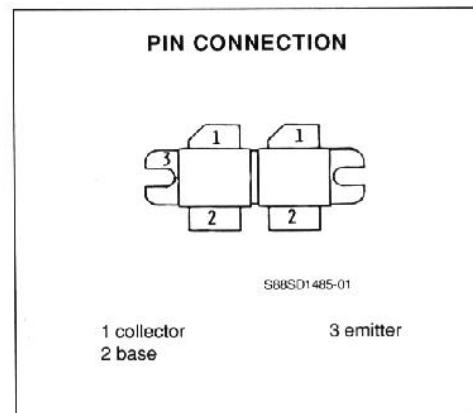
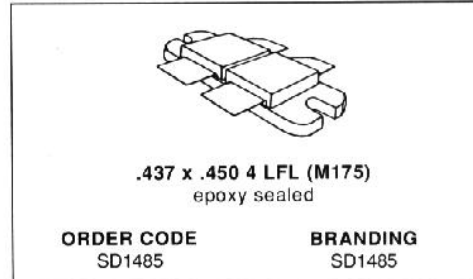

DESCRIPTION

The SD1485 is a gold metallized epitaxial silicon NPN planar transistor using diffused emitter ballast resistors for high linearity class AB operation in VHF and band III television transmitters and transposers.

ABSOLUTE MAXIMUM RATINGS ($T_{case} = 25^{\circ}C$)

Symbol	Parameter	Value	Unit
V_{CBO}	Collector - Base Voltage	65	V
V_{CEO}	Collector - Emitter Voltage	35	V
V_{EBO}	Emitter - Base Voltage	3	V
I_C	Collector Current (max.)	25	A
P_{tot}	Total Device Dissipation at + 25°C	385	W
T_{stg}	Storage Temperature	- 50 to 150	°C
T_j	Junction Temperature	200	°C

THERMAL DATA

$R_{th(j-c)}$	Junction-case Thermal Resistance $T_C = 60^{\circ}C$.45	°C/W
---------------	--	-----	------

SD1485

ELECTRICAL CHARACTERISTICS ($T_{case} = 25^{\circ}C$)

STATIC

Symbol	Test Conditions	Value			Unit
		Min.	Typ.	Max.	
BV_{CEO}	$I_C = 100mA$ $I_B = 0$	35			V
BV_{CBO}	$I_C = 100mA$	65			V
BV_{EBO}	$I_E = 20mA$	3			V
I_{CES}	$V_{CB} = 32V$			10	mA
h_{FE}	$V_{CE} = 5V$ $I_C = 4A$	20		70	

DYNAMIC

Symbol	Test Conditions	Value			Unit
		Min.	Typ.	Max.	
P_O^*	$f = 230MHz$ $V_{CE} = 32V$ $I_{CQ} = 1A$	200			W
P_G	$f = 230MHz$ $V_{CE} = 32V$ $I_{CQ} = 1A$	11			dB
nc	$f = 230MHz$ $V_{CE} = 32V$ $I_{CQ} = 1A$	50			%
V_{SWR}	$f = 230MHz$ $V_{CE} = 32V$ $P_O = 200W$	3 : 1			
C_{OB}	$f = 1MHz$ $V_{CB} = 28V$		130		pF

* 1 DB compression

POWER OUTPUT VS POWER INPUT

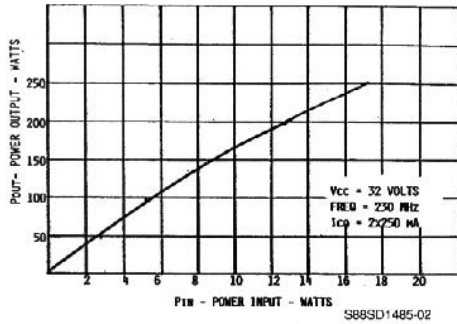

BROADBAND POWER GAIN VS FREQUENCY

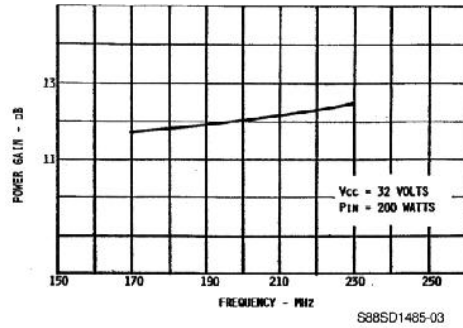

IR SCAN HOT SPOT θ_{JC} VS CASE TEMPERATURE

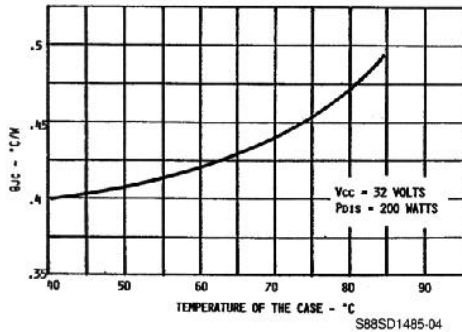

EFFICIENCY VS FREQUENCY

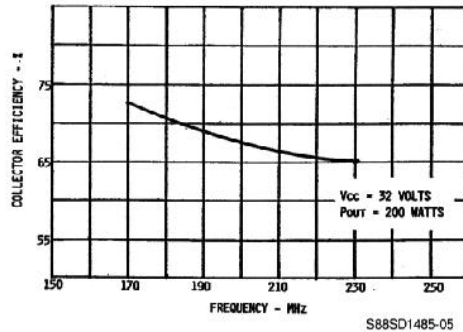

PACKAGE MECHANICAL DATA

.437 x .450 4LFL

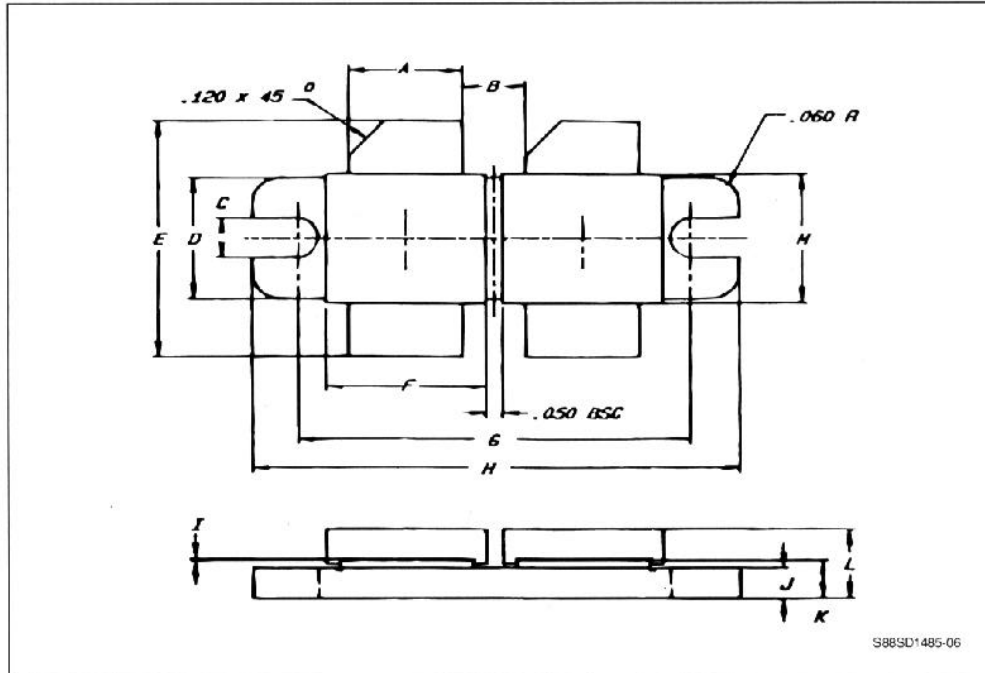

	Minimum Inches/mm	Maximum Inches/mm
A	.373/9.47	.385/9.78
B	.190/4.83 BSC	
C	.125/3.18 BSC	
D	.411/10.44	.421/10.69
E	.825/20.96	.865/21.97
F	.525/13.34	.535/13.59
G	1.255/31.88	1.265/32.13

	Minimum Inches/mm	Maximum Inches/mm
H	1.675/42.55	1.685/42.80
I	.002/0.05	.006/0.15
J	.095/2.41	.105/2.67
K	.115/2.92	.135/3.43
L		.250/6.35
M	.445/11.30	.455/11.56